



Use And Care

G U I D E



A Note To You	2
Important Safety Instructions	3
Parts And Features	4
Using Your Dishwasher	6
Loading Your Dishwasher	15
Connecting A Portable Dishwasher	19
Caring For Your Dishwasher	21
Common Dishwashing Problems	22
If You Need Assistance Or Service	25
Warranty	28

1-800-253-1301

Call us with questions or comments.

8500 SERIES DISHWASHERS

A NOTE TO YOU

A Note To You

Thank you for buying a Whirlpool® appliance.

You have purchased a quality, *world-class* home appliance. Years of engineering experience have gone into its manufacturing. To ensure that you will enjoy many years of trouble-free operation, we have developed this Use and Care Guide. It is full of valuable information on how to operate and maintain your appliance properly and safely. Please read it carefully. Also, please complete and mail the Ownership Registration Card provided with your appliance. This will help us notify you about any new information on your appliance.

Your safety is important to us.

This guide contains safety symbols and statements. Please pay special attention to these symbols and follow any instructions given. Here is a brief explanation of the use of each symbol.

WARNING

This symbol will help alert you to such dangers as personal injury, burns, fire and electrical shock.

CAUTION

This symbol will help you avoid actions which could cause product damage (scratches, dents, etc.) and damage to your personal property.

Our Consumer Assistance Center number, 1-800-253-1301, is toll-free, 24 hours a day.

If you ever have a question concerning your appliance's operation, or if you need service, first see "If You Need Assistance Or Service" on page 25. If you need further help, feel free to call our Consumer Assistance Center. When calling, you will need to know your appliance's complete model number and serial number. You can find this information on the model and serial number label (see diagram on page 4). For your convenience, we have included a handy place below for you to record these numbers, the purchase date from the sales slip and your dealer's name and telephone number. Keep this book and the sales slip together in a safe place for future reference.

Model Number _____

Dealer Name _____

Serial Number _____

Dealer Phone _____

Purchase Date _____

Important Safety Instructions

⚠ WARNING

To reduce the risk of fire, electrical shock, or injury when using your dishwasher, follow basic precautions including the following:

- Read all instructions before using the dishwasher.
- Use your dishwasher only for the uses described in this manual.
- **DISHWASHER MUST BE ELECTRICALLY GROUNDED.** Read the Installation Instructions for details.
- When discarding an old dishwasher, always remove the door to prevent accidental entrapment or suffocation.
- Use **ONLY** detergents and rinse agents recommended for use in a dishwasher.
- Store dishwasher detergent in a cool, dry place **WHERE CHILDREN CAN'T REACH IT.**
- When loading items to be washed:
 - Load sharp items and knives with the handles up to reduce risk of cut-type injuries.
 - Locate sharp items and knives so that they are not likely to damage the door or tub.
- **DO NOT** let children play in or on the dishwasher.
- **DO NOT** reach into the area below the bottom rack until the heating element has cooled for at least 20 minutes.
- **DO NOT** wash plastic items unless marked "Dishwasher Safe" or the equivalent. If not marked, check manufacturer's recommendations.
- **DO NOT** use your dishwasher unless all enclosure panels are properly in place.
- **DO NOT** sit on, stand on or abuse the dishwasher door or dish racks.
- **DO NOT** tamper with controls.
- If hot water has not been used recently (usually two weeks or longer), hydrogen gases may build up in the water heater and the hot water pipes. **HYDROGEN GAS IS EXPLOSIVE.** To prevent injury or damage, before using your dishwasher, turn on all hot water faucets and allow water to run for several minutes. This will allow gases to escape. Do not smoke or use any open flame near the faucet while it is open.
- **DO NOT** store or use gasoline or other flammable vapors and liquids in the vicinity of this or any other appliance. The fumes can create a fire hazard or explosion.
- Disconnect electrical power to the dishwasher before attempting to service.

– SAVE THESE INSTRUCTIONS –

Help us help you

Please:

- Have your dishwasher installed by a qualified installer.
- Install where dishwasher is protected from the elements.
- Install and level dishwasher on a floor that will hold the weight, and in an area suitable for its size and use.
- Properly connect dishwasher to electricity, water and drain.*
- Remove all shipping plugs from hoses and connectors (such as drain connector on a disposer) before installing.*
- Remove all hang tags and temporary labels.
- Make sure dishwasher is not used by anyone unable to operate it properly.
- Properly maintain dishwasher. See page 21.

* See Installation Instructions for complete information.

PARTS AND FEATURES

Parts And Features

This section contains captioned illustrations of your appliance. Use them to become familiar with the location and appearance of all parts and features.

NOTE: The drawings in this book may vary from your dishwasher model. They are designed to show the different features of all models covered by this book. Your model may not include all features.

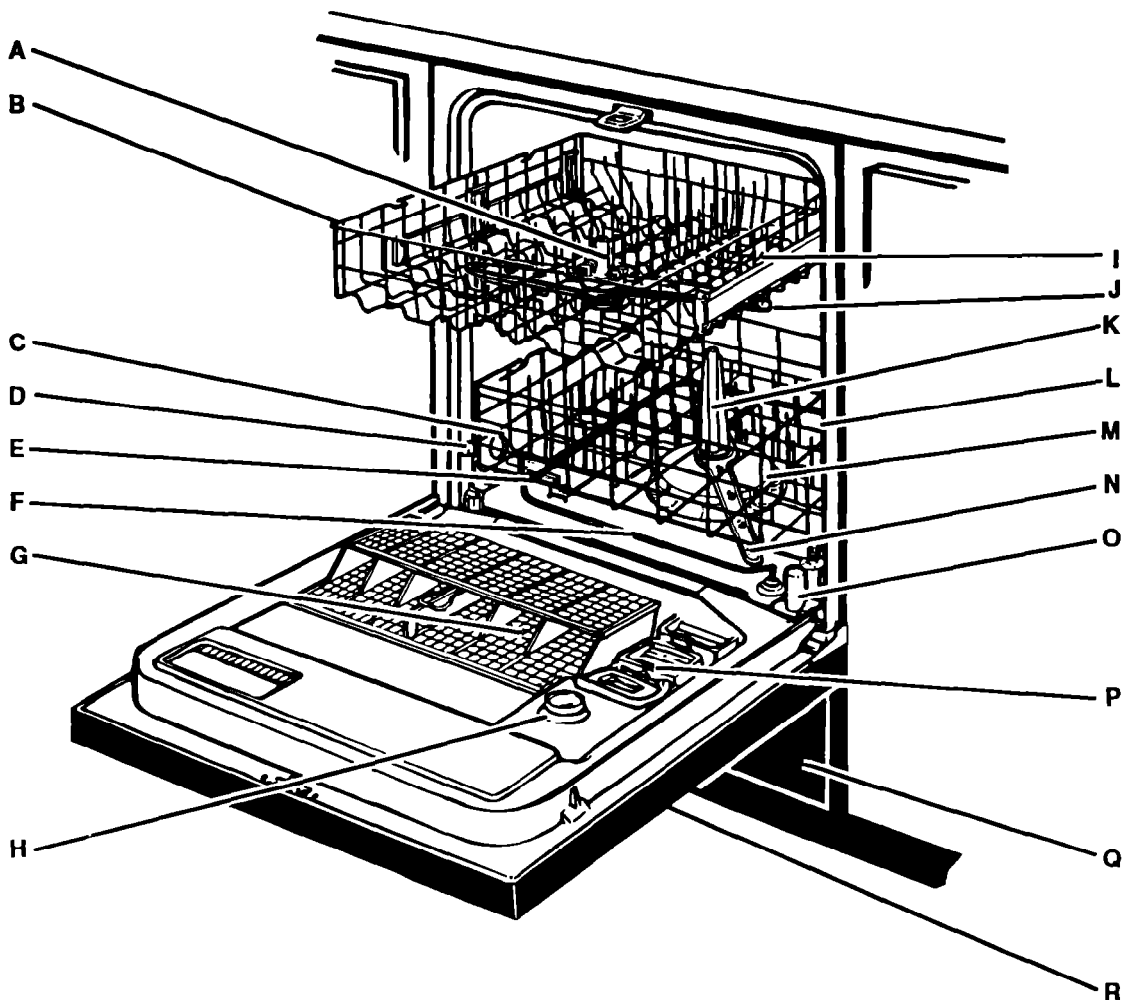

- A Third level wash
- B Top rack
- C Water inlet opening
- D Rack bumper
- E Bottom rack
- F Heating element
- G Silverware basket
- H Rinse agent dispenser
- I Top rack adjuster (on some models)
- J Upper spray arm

- K Spray tower
- L Model and serial number label
(on right side)
- M POWER CLEAN™ module
- N Lower spray arm
- O Overfill protector
- P Detergent dispenser
- Q Access panel
- R Door color panel

PARTS AND FEATURES

Control panel



Buttons

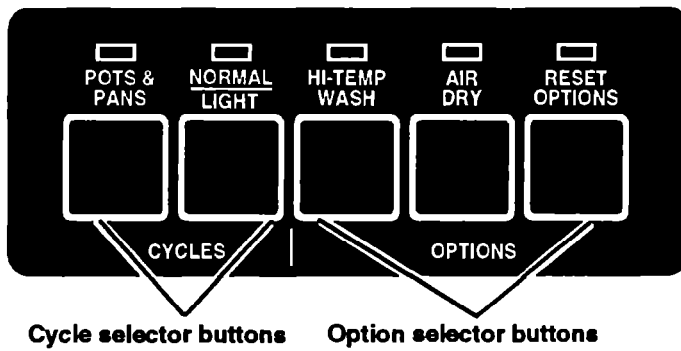

Cycle control knob

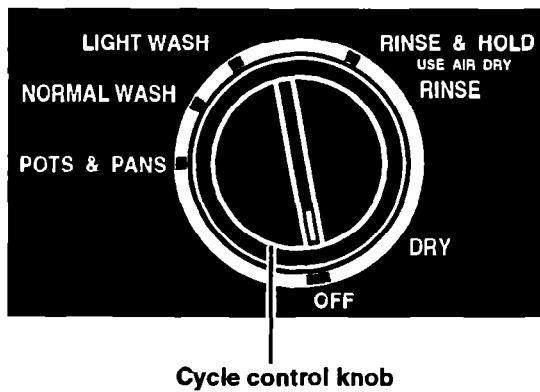





Using Your Dishwasher

In This Section		Page	Page
Before starting your dishwasher	6	What happens in each option	9
Starting your dishwasher	6	Using the detergent dispenser	10
Adding a dish during a cycle	7	Using the rinse agent dispenser	11
Changing a cycle setting	7	Quiet operating tips	12
Changing an option	7	Water temperature tips	13
Canceling a cycle	7	Energy saving tips	13
Cycle selection chart	8	Special tips on dishwasher use	14

Operating your dishwasher properly enables you to obtain the best possible results. This section explains proper dishwasher operation.

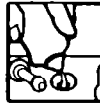
Before starting your dishwasher

1. Properly load the top rack, bottom rack, and the silverware basket. See pages 15-18. 
2. Spin both spray arms with both racks in place to make sure nothing prevents arms from turning freely. 
3. Add detergent. See pages 10 and 11. 
4. Check the rinse agent dispenser. See pages 11 and 12. 
5. Push door firmly when closing and it will automatically latch. 
6. Run hot water at sink nearest dishwasher until water is hot. Turn off water. 

Starting your dishwasher

The dishwasher will wash and dry dishware according to the selections you make on the control panel.

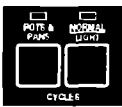
1. Push a Cycle Selector button for the desired cycle. The indicator above the button will show red for the selected cycle. 

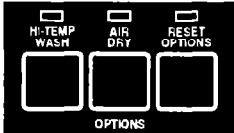
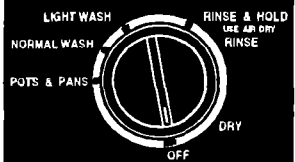
NOTE: Normal Wash, Light Wash and Rinse & Hold cycles share the same button. The Cycle Control knob determines which cycle operates.
2. Push an Option Selector button for each desired option. The indicator above the button will show red for the selected option. 
3. Turn the Cycle Control knob clockwise to point to the desired cycle. You will feel a definite stop at each cycle mark. The dishwasher will automatically start the cycle you selected. 

NOTE: If the door is latched, you will hear cycles start and stop as the knob passes each cycle mark. This is normal and will not hurt the dishwasher. If you prefer, you can set cycles with the door unlatched.

Adding a dish during a cycle

You can add an additional item to the dishwasher anytime before the Cycle Control knob reaches LIGHT WASH. See page 8.

1. Lift up on the door latch to unlatch the door and stop the cycle. Wait a moment for the spray action to stop before opening the door.
2. Open the door and add the dish.
3. Close the door. **Do not latch it.** Wait 30 seconds for air in the dishwasher to warm up. This helps reduce the amount of moisture that can come from the vent when restarting the cycle.
4. Press door in to latch it. The dishwasher will start where it stopped.

Changing a cycle setting

You can change a setting anytime during any cycle.

1. Lift up on the door latch to unlatch the door and stop the cycle.
2. Turn the Cycle Control knob clockwise to the cycle you want.
3. Push the desired Cycle Selection button.
4. Check the detergent dispenser to be sure it is properly filled for the new cycle. See page 10.
5. Close and latch the door. The dishwasher will automatically start the new cycle.

NOTE: Turning the Cycle Control knob may cause the covered section of the detergent dispenser to open. Be sure to fill the covered section if the cycle uses detergent in both sections.

Changing an option

You can change an option anytime during a cycle. To change the selected option(s):

1. Push the RESET OPTIONS button.
2. Push an Option Selector button for each desired option.





Canceling a cycle

You can cancel a cycle anytime during the cycle.

1. Turn the Cycle Control knob slowly clockwise to the drain portion of the wash or rinse. You will hear water draining when you have advanced to the proper location.
2. Let the dishwasher drain completely.
3. Lift up on the door latch to unlatch the door.
4. Turn the Cycle Control knob clockwise to point to OFF.

USING YOUR DISHWASHER

Cycle selection chart

Cycle	A "*" shows what steps are in each cycle						Cycle Time (Minutes)
	Wash	Rinse	Main Wash	Rinse	Rinse	Dry	
Pots & Pans  A double wash for maximum cleaning of cooked-on or baked-on foods. NOTE: The Cycle Control knob stops while the dishwasher heats water to 135°F (57°C) in both washes and the final rinse (marked †). See page 9.	•†	•	•†	•	•†	•	90-120*
Normal Wash  A double wash for normal, everyday soiled loads. (The Energy Guide Label is based on this cycle.) NOTE: The Cycle Control knob does not move while the dishwasher heats water to 135°F (57°C) in the final rinse (marked †). If the Hi-Temp Wash option is selected water will also be heated in the main wash (marked ††). See page 9.	•		•††	•	•†	•	66*
Light Wash  A single wash for pre-rinsed or lightly soiled loads. NOTE: The Cycle Control knob does not move while the dishwasher heats water to 135°F (57°C) in the final rinse (marked †). If the Hi-Temp Wash option is selected water will also be heated in the main wash (marked ††). See page 9.			•††	•	•†	•	60*

* Cycle time includes heated dry time. Cycle time may vary depending on the temperature of the water entering the dishwasher.

USING YOUR DISHWASHER

Cycle	A "*" shows what steps are in each cycle						Cycle Time (Minutes)
	Wash	Rinse	Main Wash	Rinse	Rinse	Dry	
<p>Rinse & Hold</p>  <p>For rinsing a few items to be washed one or more days later. Do not use detergent. Use Air Dry option. Drying with heat may cause food to bake on dishes.</p> <p>NOTE: The Cycle Control knob does not move while the dishwasher heats water to 135°F (57°C) in the final rinse (marked †).</p>				•	*†		16

What happens in each option

Hi-Temp Wash option



If the Hi-Temp Wash option is selected, water is heated in the dishwasher during the main wash of the Normal Wash and Light Wash cycles to improve washability. The Hi-Temp Wash option is automatically selected for the Pots & Pans cycle. See "Cycle selection chart" on page 8.

NOTE:

- The Cycle Control knob does not move while the water is heating.
- When the water temperature reaches 135°F (57°C), the Cycle Control knob will begin moving again.
- The heating time is based on the temperature of the water supply as it enters the dishwasher. The cooler the water, the longer the heating time.
 - If water temperature at the faucet is below 120°F (49°C), have a qualified person raise the water heater's thermostat setting. See page 13.
- The dishwasher does not pause to heat the water if the water entering the dishwasher is already 135°F (57°C).

Air Dry option



If the Air Dry option is selected, air in the dishwasher is not heated during the "dry" part of the cycle. Using this option helps save energy, but dishes take longer to dry (overnight) and some water spotting may result. Some items (such as plastics) may need towel drying. For best drying results, use a liquid rinse agent.

Using the detergent dispenser

What type of detergent to use

- Use automatic dishwasher detergent only. Other detergents are too mild and much too sudsy to work in the dishwasher.
- Follow manufacturer's directions when using liquid automatic dishwasher detergent or concentrated powder detergent.
- Do not add detergent until you are ready to wash.
- Store detergent tightly closed in a cool, dry place. **Fresh automatic dishwasher detergent is necessary for best washing results.**

NOTE: Different brands of dishwasher detergent have different amounts of phosphorus for softening water. If water is hard and phosphorus content is low (6.0% or less), you may need to:

- Use more detergent.
- OR**
- Use a brand with a higher phosphorus content (8.7%).

The detergent dispenser

The detergent dispenser has one section with a cover and one without.

- Put detergent in both sections for cycles with two washes. See "Cycle selection chart" on pages 8 and 9.
- Put detergent only in the covered section for cycles with one wash. See "Cycle selection chart" on pages 8 and 9.

- Push the cover down until it is latched. Detergent in the open section falls into the dishwasher when the door is closed. The covered section opens automatically when the main wash starts.

NOTE: It is normal for cover to open partially when dispensing detergent. The cover will open fully when the door is opened.

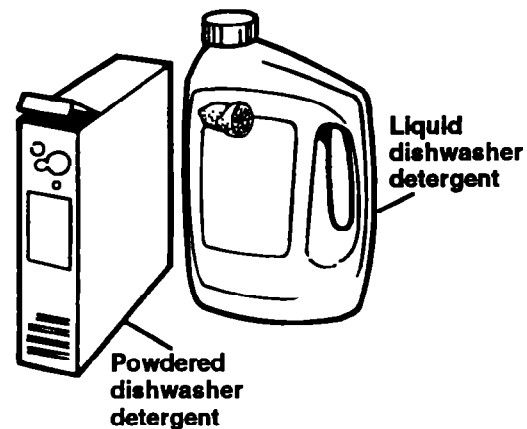

See phosphorus content on package labels

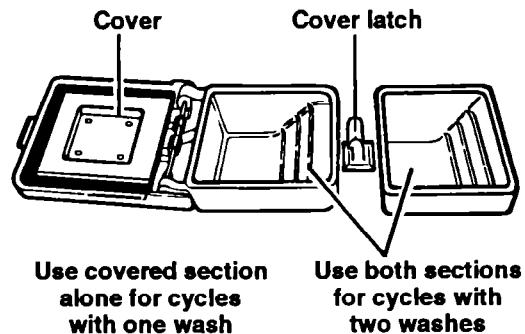

How much detergent to use

The amount of detergent to use depends on the hardness of your water. If too little is used, dishes won't be clean. However, if too much is used in soft water, glassware will begin to etch.

- **HARD**—Fill one or both sections to the top of the third step (3 tablespoons) if water hardness is 8 or more grains per gallon, or 136 or more parts per million.
- **MEDIUM**—Fill one or both sections to the top of the second step (2 tablespoons) if water hardness is 5 to 7 grains per gallon, or 85 to 119 parts per million.
- **SOFT**—Fill one or both sections to the top of the first step (1 tablespoon) if water hardness is 0 to 4 grains per gallon, or 0 to 68 parts per million.

Find out your water's hardness by asking your local water department, water softener company or county extension agent.

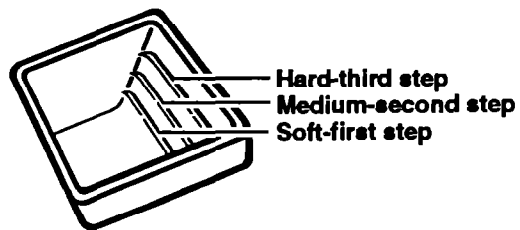

Using the rinse agent dispenser

Rinse agent dispenser

Keep the rinse agent dispenser filled with a liquid rinse agent. A rinse agent greatly improves the drying of dishes by helping water flow off them during the last rinse. A rinse agent also keeps water from forming droplets and drying as spots.

Release of a small amount of rinse agent into the rinse water is automatic in the final rinse of each cycle. For best drying results, check the dispenser periodically to see if it needs refilling.

To check dispenser

Remove dispenser cap. If dispenser is empty, an "E" will be clearly visible inside the dispenser.



"E" shows when empty

USING YOUR DISHWASHER

On some models:

The center of the Fill Indicator Cap will be clear when dispenser needs refilling.

On some models:

1. Press the flexible clear top of the Fill Indicator Cap to draw rinse agent into cap.

NOTE: You may need to press cap two or three times to remove all of the air bubbles from the cap.

2. When rinse agent does not show in cap, even after pressing flexible cap several times, dispenser needs refilling.

To fill dispenser

You do not have to wait until the dispenser is empty to refill it, but do not overfill it. The dispenser will hold 6 ounces (175 mL) of rinse agent. Under normal conditions, this will last about 3 months.

1. Make sure the dishwasher door is fully open.
2. Remove the Fill Indicator Cap.
3. Add rinse agent to the dispenser. Do not fill past the smallest opening in the lower part of the dispenser.
If you overfill, excess rinse agent can come out. This will not harm the dishwasher, but could cause over-sudsing.
4. Clean up any spilled rinse agent with a damp cloth.
5. Replace the Fill Indicator Cap and keep it tightly closed.

NOTE: Your dishwasher is designed to use a liquid rinse agent. You do not need to use a solid or bar-type rinse agent.

Center will be clear when empty, on some models

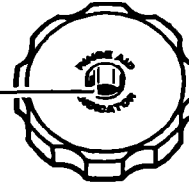

Press flexible clear top, on some models



Keep rinse agent dispenser filled for best drying results

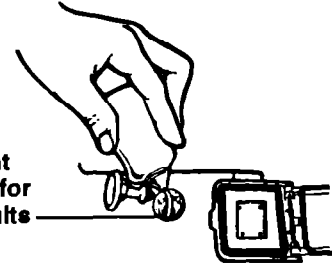

Do not fill past smallest opening



Quiet operating tips

To avoid thumping and clattering noises during operation:

- Make sure lightweight load items are secured in the racks.
- Make sure pot lids and handles, pizza pans, cookie sheets, etc. do not touch interior walls or interfere with the spray arm's rotation or cover the spray tower.

- Load dishes so they do not touch one another.

NOTE: Keep sink drain plugs inserted during dishwasher operation to prevent noise transfer through drains.

Water temperature tips

Hot water dissolves and activates the dishwashing detergent. Hot water also dissolves grease on dishes and helps dry glasses spot-free. The dishwasher will automatically heat water to 135°F (57°C) during the final rinse. Use the Hi-Temp Wash option if you keep your water heater at a low setting.

For best dishwashing results, water must be at least 120°F (49°C) as it enters the dishwasher.

To check water temperature

1. Run hot water at the faucet closest to your dishwasher. Let the water run for at least one minute.
2. Measure the water temperature with a candy or meat thermometer. Put the thermometer in the running stream of water.
3. If the water temperature at the faucet is below 120°F (49°C), have a qualified person raise the water heater's thermostat setting.

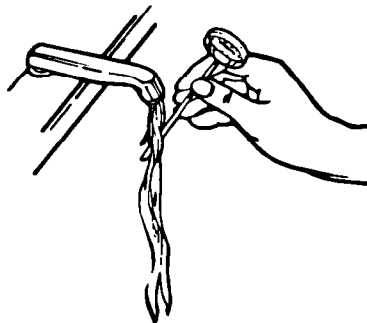

Energy saving tips

You can help save energy if you:

- Wash full loads. Running a half-filled dishwasher uses the same amount of electricity and hot water as a fully loaded machine.
 - Use the Light Wash cycle whenever possible. The cycle uses less hot water and energy than the Normal Wash cycle.
 - Use the Air Dry option when you don't need a rapid drying cycle. Allow longer drying times (overnight). Use a rinse agent to improve drying.
 - Do not use the Hi-Temp Wash option. When this option is off, the dishwasher will not pause to heat water to 135°F (57°C) during the main wash.
- NOTE:** Loads may not wash as well if the water temperature is too low.
- Load correctly for best washing results. Incorrect loading may cause poor washing and the need to rewash all or part of the load.
 - Do not pre-rinse normally soiled dishes. Select the correct cycle for the load and use the recommended amount of detergent for good washing results without hand rinsing.
 - Use your dishwasher during off-peak hours. Local utilities recommend this to avoid heavy usage of energy at certain times of day.

USING YOUR DISHWASHER

Special tips on dishwasher use

If you have any doubts about washing a particular piece of dishware, check with the manufacturer to see if it is dishwasher safe.

NOTE: It is the user's responsibility to determine if dishware should be washed in a dishwasher.

Material	Dishwasher Safe?	Exceptions/Special Information
Aluminum	Yes	High water temperature and detergents may affect finish of anodized aluminum.
Bottles and Can	No	Labels attached with glue can loosen during a wash. Loose labels can clog spray arms or the pump and will reduce washing performance. Remove labels before putting items in dishwasher or wash by hand.
Cast Iron	No	Seasoning will be removed and iron will rust.
China/ Stoneware	Yes	Always check manufacturer's recommendations before washing. Antique, hand-painted or over-the-glaze patterns may fade. Gold leaf may discolor or fade.
Crystal	Yes	Always check manufacturer's recommendations before washing. Some types of leaded crystal may etch with repeated washings.
Gold	No	Gold-colored flatware will discolor.
Glass	Yes	Milk glass will yellow with repeated dishwasher washing.
Hollow-Handle Knives	No	Handles of some knives are attached to the blade with adhesives which may loosen if washed in the dishwasher.
Pewter	No	High water temperatures and detergent may discolor or pit finish.
Disposable Plastics	No	Cannot withstand high water temperatures and detergents.
Plastics	Yes	Always check manufacturer's recommendations before washing. Plastics vary in their capacity to withstand high water temperatures and detergents.
Stainless Steel	Yes	Run a Rinse & Hold cycle if not washing immediately. Prolonged contact with foods containing salt, vinegar, milk products or fruit juice could damage finish.
Sterling Silver or Silver Plate	Yes	Run a Rinse & Hold cycle if not washing immediately. Prolonged contact with food containing salt, acid or sulfide (eggs, mayonnaise and seafood) could damage finish.
Tin	No	May rust.
Wooden Ware	No	Always check manufacturer's recommendations before washing. Untreated wood may warp, crack or lose its finish.

Loading Your Dishwasher

In This Section		Page	Page
Preparing to load the dishwasher ...	15	Loading the bottom rack	17
Loading the top rack	15	Loading the silverware basket	18

This section tells you how to properly load your dishwasher for the best washing and rinsing results.

Preparing to load the dishwasher

- To save water and energy, do not rinse dishes before putting them into the dishwasher.
- Remove large pieces of food, bones and other hard items. The POWER CLEAN™ module will remove food particles from the water. The module contains a chopping device which will reduce the size of food items.
NOTE: If hard items such as fruit seeds, nuts and egg shells enter the POWER CLEAN module, you might hear chopping, grinding, crunching or buzzing sounds. Those sounds are normal when hard items enter the module. Do not let metallic items (such as pot handle screws) get into the POWER CLEAN module. This could damage the POWER CLEAN module.
- Foods like eggs, rice, pasta, and cooked cereals may be hard to remove if they are left to dry over a period of time.
Run a Rinse & Hold cycle to keep dishes moist if you do not plan to wash them soon.
- Load dishes so soiled surfaces face the rotating spray arms.
- Load dishes so they are not stacked or overlapping. It is important for the water spray to reach all soiled surfaces for best washing. For best drying, water must be able to drain from all surfaces.

Loading the top rack

The top rack is designed for cups, glasses and smaller items. Do not cover the third level wash when loading the top rack.

Cup and glass load

- Place so open ends face down for cleaning and draining.
- Load glasses in top rack only—bottom rack is not designed for glasses. Damage may occur.
- Place items in the rows between prongs. Placing them over the prongs can lead to breakage.
- Be sure lightweight items are held firmly in place.
- China, crystal and other delicate items must not touch each other during dishwasher operation. Damage may occur.

Do not cover third level wash

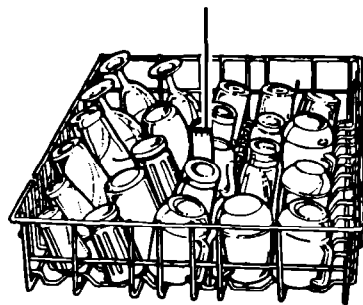

Cup and glass load

LOADING YOUR DISHWASHER

Mixed load

- Load plastic items in the top rack only. Only plastic items marked "dishwasher safe" are recommended.
- Load plastic items so the force of the spray does not move them during the cycle.
- Plastic items can be melted in the bottom rack.

Utensil load

- Small bowls, pans and other utensils can be placed in the top rack.

Adjustable 3-position top rack (on some models)

You can raise or lower the rack to fit tall items in either the top or bottom rack. The high and low positions are marked on the adjuster on the side facing the center of the dishwasher.

1. Hold the top rack with one hand near the adjuster.
2. Pull the top of the adjuster lever out with the other hand.
3. Lift or lower the rack to one of the preset positions.
4. Release the adjuster lever.
5. Repeat Steps 1-4 for the three remaining adjusters as needed. The four adjusters can be raised or lowered separately or together, as desired. The top rack does not have to be level.

Do not cover third level wash

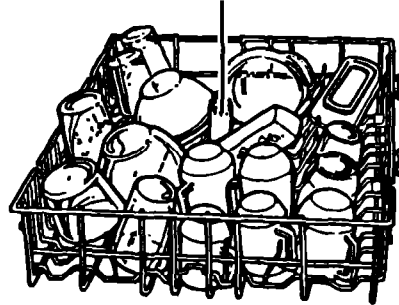

Mixed load

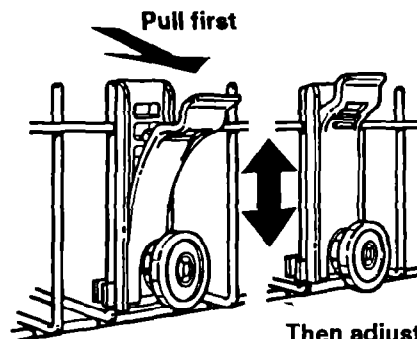

Then adjust

Loading the bottom rack

Items with cooked-on or dried-on food should be loaded in the bottom rack, with soiled surfaces facing inward to the spray.

Mixed load

- Make sure pot handles and other items do not stop rotation of the lower spray arm. Spray arm must move freely.
- Load items so they do not block or cover the spray tower.
- Securely place heavily soiled cookware face down in rack.

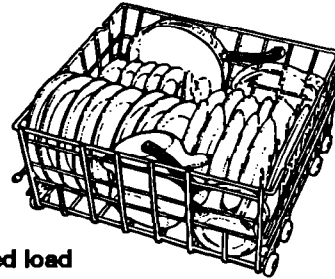

Mixed load

Dish load

- Place plates, soup bowls, etc., between prongs and facing inward to the spray.
- Do not place items directly over spray tower.

Utensil load

- Load cookie sheets, cake pans and other large items at sides and back. Loading such items in front may keep water spray from reaching detergent dispenser and silverware basket.

NOTE:

- Do not load glasses, cups or plastic items in the bottom rack.
- When lower rack is removed, replace with bumpers in front.

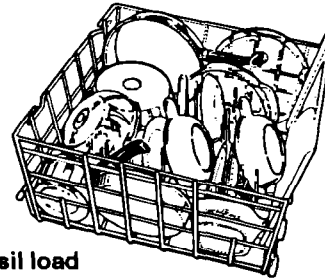

Utensil load

LOADING YOUR DISHWASHER

Loading the silverware basket

⚠ WARNING

Personal Injury Hazard

Load sharp items (knives, forks, skewers, etc.), with the point down.

Failure to do so could cause personal injury.

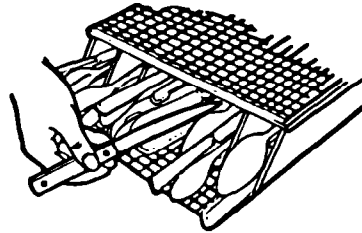

- Load the silverware basket while it is in the door or take the basket out for loading on a counter or table.

NOTE: The basket can also be removed for easy unloading. Always unload or remove the basket before unloading the racks to avoid spilling water droplets on the silverware.

- Load forks and spoons so they don't nest together. Spray cannot reach nested items.
- Mix items in each section of the basket with some pointing up and some down.
- Small items (baby bottle caps, jar lids, etc.) can be put in any section.

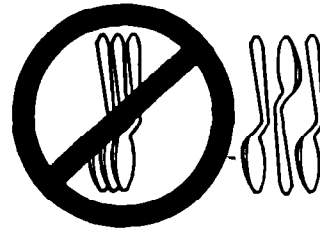

To remove the basket

1. Grab the basket by the handle and slide it towards the top of the door.
2. Lift the basket off the holding buttons.

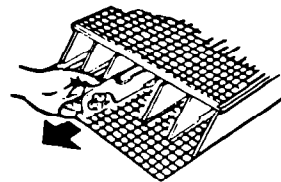

To replace the basket

1. Set the basket on the holding buttons.
2. Slide the basket towards the bottom of the door until it locks in place.

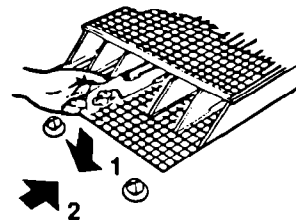

To open the basket

Unhook the latch as shown.

NOTE: Be sure the cover is completely latched before pulling out the bottom rack and before closing the dishwasher door.

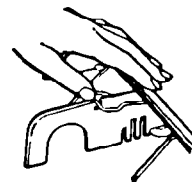

Connecting A Portable Dishwasher

NOTE: A special adapter must be installed on the faucet before the dishwasher can be connected. Complete instructions and the adapter are packed with your dishwasher.

When moving your dishwasher make sure the door is latched. Hold the dishwasher at the top front corners.

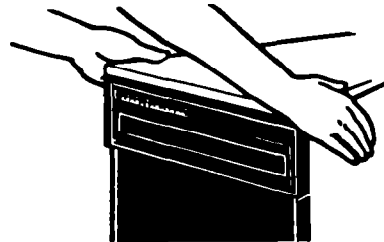

Before starting

1. Run water at faucet until it is hot. Turn water off.
2. Pull hoses out of their storage compartment on the back of the dishwasher.

NOTE: Make sure the hoses are not kinked or twisted. Kinked hoses reduce washing performance.

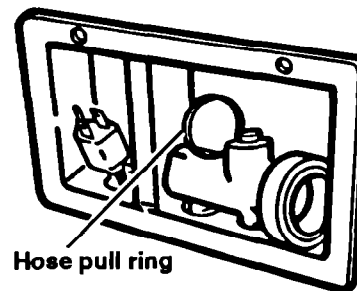

3. Pull down on the locking collar while lifting the hose connector onto the faucet adapter.
4. When the connector snaps into place, release the locking collar.
5. Turn the hot water on slowly until it is all the way on.
6. Plug in power supply cord.
7. See page 6 for instructions on how to start the dishwasher.

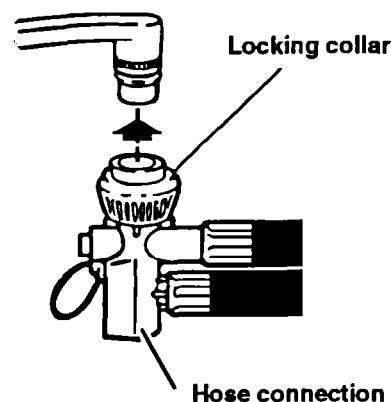

While dishwasher is running

You can draw water from the faucet while the dishwasher is connected. **Do not** draw water while the dishwasher is filling or while water is being pumped out. (This helps prevent a low fill when dishwasher is filling or mixing drain water with fresh water.)

- Press the red button on the hose connector to draw water from faucet. (The faucet is set on hot. Adjust faucet for the water temperature you want.)

NOTE: Turn hot water back on after you draw water from faucet. Turn off cold water.

CONNECTING A PORTABLE DISHWASHER

When cycle is finished

1. Turn hot water off. (This can be done after the last rinse.)
2. Press the red button on the connector to release the water pressure.
3. Lift slightly on the hose connector while pulling down the locking collar. Pull down on the connector.
4. Empty any remaining water from the connector by turning the connector upside-down.
5. Unplug power supply cord and return to storage compartment.
6. Return hoses to storage compartment.

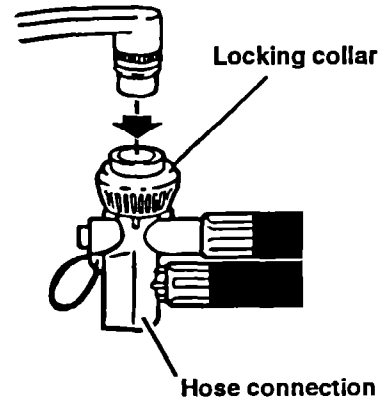

Electrical connection

A power supply of 120 volts, 60Hz AC, 15 or 20 amps, is required. For your personal safety, this appliance must be grounded. This appliance is equipped with a power supply cord having a 3-prong grounding plug. To minimize possible shock hazard it must be plugged into a mating 3-prong grounding type wall receptacle, grounded in accordance with the National Electrical Code and local codes and ordinances. If a mating wall receptacle is not available, it is the responsibility and obligation of the customer to have a properly grounded 3-prong wall receptacle installed by a qualified electrician.

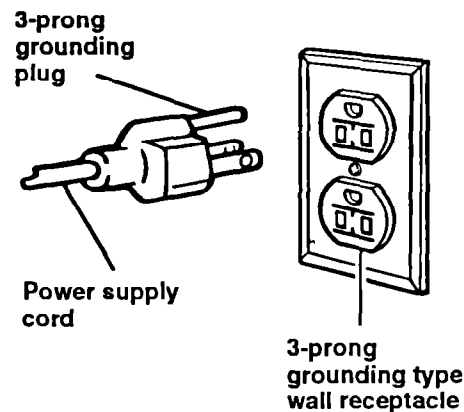

⚠ WARNING

Personal Injury Hazard

An extension cord should not be used with this appliance.

Such use may result in a fire, electrical shock or other personal injury.

Do not, under any circumstances, remove the power supply cord ground prong.

Converting to built-in

Your Whirlpool Portable Dishwasher can be converted to a built-in (undercounter) model by using conversion kit No. 4317856. The kit is available at your Whirlpool dealer or authorized Whirlpool® service company. Instructions are included with the kit.

Caring For Your Dishwasher

Your new dishwasher is designed to give you many years of dependable service. There are a few things you can do to maintain your dishwasher properly. This section tells you how to clean and care for your dishwasher. Refer to "Solution chart" on pages 22-24 for special cleaning problems.

⚠ WARNING

Personal Injury Hazard

Before cleaning interior, wait at least 20 minutes after a cycle for the heating element to cool down.

Failure to do so could result in burn injuries.

Caring for simulated wood top (on portable models)

The simulated wood top can be used as a utility work surface for most kitchen jobs. It is stronger and more easily cleaned than genuine wood.

The top can be used as a cutting board. Knife marks will be visible, but will not seriously damage top. Hot items from the oven can be placed on the top.

Clean with warm, soapy water. For dried-on foods, use a scouring pad.

Cleaning the exterior

In most cases, regular use of a soft, damp cloth or sponge and a mild detergent is all that is necessary to keep the outside of your dishwasher nice looking and clean.

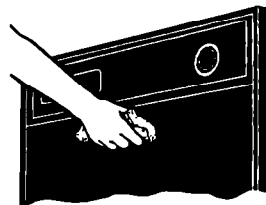

Cleaning the interior

Hard water minerals may cause a white film to build up on the inside surfaces, especially just beneath the door area. To clean interior:

- Apply powdered dishwasher detergent to a damp sponge to make a paste.

OR

- Use liquid automatic dishwasher detergent and clean with damp sponge.

Wear rubber gloves. **Do not** use any type of cleanser other than dishwasher detergent because it may cause foaming or sudsing.

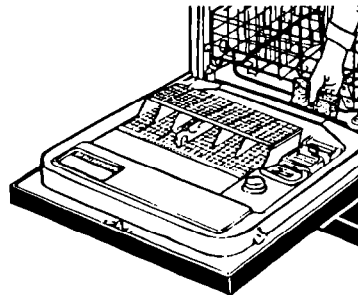

Common Dishwashing Problems

In This Section		Page	Page
Solution chart	22	Removing spots and film	25

Solution chart

A convenient checklist for handling minor performance problems. Go over this list before calling for service. If you are unable to solve your dishwasher's problem, turn to page 25 for service information.

Problem	Cause	Solution
Food Soil Left on Dishes	Improper loading	Follow loading instructions on pages 15-18.
	Water temperature is too low	Use the Hi-Temp Wash option. If needed, turn home water heater up to ensure water entering dishwasher is 120°F (49°C) minimum. See recommended procedure on page 13.
	Use of incorrect, too little or ineffective detergent	Use recommended dishwasher detergents only. Follow recommendations on pages 10 and 11 for amounts; never use less than one tablespoon per load. Detergent must be fresh to be effective. Always store detergent in a cool, dry area, preferably in an airtight container.
	Detergent cakes in dispenser	Use fresh detergent only. Do not allow detergent to sit for several hours in a wet dispenser. Check dispenser for caked detergent. Clean dispenser when caked detergent is present.
	Pump or spray arm clogged by labels from bottles and cans	Remove labels before washing or wash by hand. See page 14.
	Low water pressure due to insufficient fill	Home water pressure should be 20 to 120 psi for proper dishwasher fill. A booster pump on the water supply may be necessary if pressure is too low.
Spotting and Filming	Slowdown of wash arm due to high suds	Never use soap or laundry detergents. Use recommended dishwasher detergents only.
	Hard water or high mineral content in water	Conditioning the final rinse water with a liquid rinse agent helps eliminate spotting and filming. Keep the dispenser filled with a rinse agent at all times.

COMMON DISHWASHING PROBLEMS

Problem	Cause	Solution
Spotting and Filming (continued)	<p>Water temperature is too low</p> <p>Use of incorrect detergents</p> <p>Incorrect amount of detergent</p> <p>Use of ineffective detergents</p> <p>Insufficient fill caused by low water pressure</p>	<p>Use the Hi-Temp Wash option. If needed, turn home water heater up to ensure water entering dishwasher is 120°F (49°C) minimum. See recommended procedure on page 13.</p> <p>Use recommended dishwasher detergents only.</p> <p>Follow recommendations on page 10 for amount. Heavy soil and/or hard water generally require extra detergent.</p> <p>Detergent should be fresh. Store in a cool, dry place, preferably in an airtight container. Discard lumpy detergent.</p> <p>Home water pressure should be 20 to 120 psi for proper dishwasher fill. A booster pump on the water supply may be necessary if pressure is too low.</p>
Cycle Takes Extremely Long Time	Water temperature is too low	If needed, turn home water heater up to ensure water entering dishwasher is 120°F (49°C) minimum. See recommended procedure on page 13.
Dishes Do Not Dry Completely	<p>Dishes do not drain properly</p> <p>Plastics</p>	<p>Dishes must have proper water drainage. Do not overload. Follow instructions for loading dishwasher on pages 15-18. Use a liquid rinse agent to speed draining.</p> <p>Some plastics, due to material, may need to be towel dried.</p>
Silica Film or Etching (Silica Film is a White Iridescent Deposit; Etching is a Cloudy Film)	A water chemical reaction with certain types of glassware. Usually caused by some combination of soft or softened water, alkaline washing solutions, insufficient rinsing, over-loading the dishwasher, and heat of drying.	It may not be possible to prevent problem, except by hand-washing. To retard this process, use a minimum amount of detergent but not less than one tablespoon per load. Use a liquid rinse agent and underload the dishwasher to allow thorough rinsing. Silica film and etching are permanent and can not be removed. Use the Air Dry option.
Black or Gray Marks on Dishes	Aluminum items	Aluminum items should be loaded so that they will not rub against dishes during washing. Throw-away aluminum items should not be washed in the dishwasher because they may break down and cause marking. Aluminum markings can be removed by using a mild abrasive cleanser.

COMMON DISHWASHING PROBLEMS

Problem	Cause	Solution
Brown Stains on Dishes and Dishwasher Interior	High iron content in water supply	Remove by washing dishes (after food soil has been removed) with 1 teaspoon to 1 tablespoon of citric acid crystals added to covered section of detergent dispenser. Do not use detergent. Follow with a Light Wash cycle with detergent. If treatment is needed more often than every other month, the installation of an iron removal unit is recommended.
Orange Stains on Dishwasher Interior	Large amounts of tomato based foods on dishes placed in the dishwasher.	Stains may gradually fade over time. Regular use of Heat Dry option may cause stains to fade slower. Stains will not affect dishwasher performance. Regular use of Rinse & Hold cycle with Air Dry option for partial loads will reduce the likelihood of staining.
White Spots on Cookware with Non-Stick Finish	Seasoning removed by dishwasher detergents	Re-season cookware after dishwasher washing.
Odor in the Dishwasher	Dishes only washed every two to three days	Run a Rinse & Hold cycle at least once or twice a day until a full load is accumulated.
Chipping of Dishes	Improper loading	Load dishes and glasses so that they are stable and do not strike together from washing action. Moving racks in and out smoothly will also minimize chipping. NOTE: Some types of china and glassware are too delicate for automatic dishwashing and should be hand-washed; for example: antiques, feather-edged crystal and similar types.

IF YOU NEED ASSISTANCE OR SERVICE

Removing spots and film

Keep the rinse agent dispenser filled with a liquid rinse agent. A rinse agent prevents water from forming droplets and drying as spots or streaks.

To remove spots and film on dishes and glasses, or hard water film on the interior of the dishwasher, you may use white vinegar with the following procedure:

1. Load clean dishes and glasses in dishwasher in regular manner. Do not load silverware or other metals in the dishwasher.
2. Close and latch door.
3. Select the Normal Wash cycle and Air Dry option. Do not use detergent.
4. Allow dishwasher to run through the first wash. When washer has filled for main wash portion of cycle, unlatch and open door.
5. Pour 2 cups of household vinegar into the dishwasher.
6. Close and latch door. Allow dishwasher to finish the cycle.

If You Need Assistance Or Service

This section is designed to help you save the cost of a service call. When calling our Consumer Assistance Center for help or calling for service, please provide a detailed description of the problem, your appliance's complete model and serial numbers and the purchase date. (See page 2.) This information will help us respond properly to your request.

1. Before calling for assistance ...

Please check the chart below for problems you can fix. It could save you the cost of a service call.

PROBLEM	CHECK THE FOLLOWING
Dishwasher does not run or stops during a cycle	<p>Is the door tightly closed and securely latched?</p> <p>Has the cycle been set correctly? See page 6.</p> <p>Has a household fuse or circuit breaker blown or tripped?</p> <p>If the motor has stopped because of an overload, it will automatically reset itself within a few minutes. If the motor does not start, call for service.</p> <p>Is the water supply turned on?</p> <p>Is the dishwasher wired into a live circuit with the proper voltage?</p> <p>The dishwasher will run longer while heating the water. This is normal for lower incoming water temperatures. See page 9.</p>
Dishwasher seems to run too long	<p>Is overfill protector stuck in "up" position? Overfill protector should move up and down freely. Press down to release.</p>

continued on next page

IF YOU NEED ASSISTANCE OR SERVICE

PROBLEM	CHECK THE FOLLOWING
Dishwasher will not fill	Wait for the cycle to finish. A small amount of water remaining is normal.
Water remains in dishwasher	Check the drain air gap (if installed). If it is clogged follow the manufacturer's cleaning instruction.
Detergent remains in covered section of dispenser	Has the cycle completed? Is the detergent fresh and dry without lumps? Is the bottom rack in backwards? The rack bumpers should face the door.
Dishes are not as dry as you expected	Is the rinse agent dispenser empty? Using a rinse agent greatly improves drying. See page 11. Do not use Air Dry option on the next load. See page 9.
Grinding, grating, crunching or buzzing sounds	Has a hard object entered the POWER CLEAN™ module? The sound should stop when the object is ground up.
White residue appears on front of access panel	Is too much detergent being used? See page 10 for recommended amounts of detergent. Some liquid detergents develop excess foam and build up on access panel. Try a different brand to reduce foaming and eliminate build-up.

2. If you need assistance*...

Call Whirlpool Consumer Assistance Center telephone number. Dial toll-free from anywhere in the U.S.A.:

1-800-253-1301

and talk with one of our trained consultants. The consultant can instruct you in how to obtain satisfactory operation from your appliance or, if service is necessary, recommend a qualified service company in your area.

If you prefer, write to:

Mr. William Clark
Consumer Assistance Representative
Whirlpool Corporation
2000 M-63
Benton Harbor, MI 49022

Please include a daytime phone number in your correspondence.

3. If you need service*...



Whirlpool has a nationwide network of authorized Whirlpool® service companies. Whirlpool service technicians are

trained to fulfill the product warranty and provide after-warranty service anywhere in the United States. To locate the authorized Whirlpool service company in your area, call our Consumer Assistance Center telephone number (see Step 2) or look in your telephone directory Yellow Pages under:

• **APPLIANCE-HOUSEHOLD-MAJOR, SERVICE & REPAIR**
- See: Whirlpool Appliances or Authorized Whirlpool Service
(Example: XYZ Service Co.)

• **WASHING MACHINES & DRYERS, SERVICE & REPAIR**
- See: Whirlpool Appliances or Authorized Whirlpool Service
(Example: XYZ Service Co.)

IF YOU NEED ASSISTANCE OR SERVICE

4. If you need FSP® replacement parts ...

FSP is a registered trademark of Whirlpool Corporation for quality parts. Look for this symbol of quality whenever you need a replacement part for your Whirlpool® appliance. FSP replacement parts will fit right and work right, because they are made to the same exacting specifications used to build every new Whirlpool appliance.

To locate FSP replacement parts in your area, refer to Step 3 above or call the Whirlpool Consumer Assistance Center number in Step 2.

5. If you are not satisfied with how the problem was solved ...

- Contact the Major Appliance Consumer Action Panel (MACAP). MACAP is a group of independent consumer experts that voices consumer views at the highest levels of the major appliance industry.
- Contact MACAP only when the dealer, authorized servicer and Whirlpool have failed to resolve your problem.

Major Appliance Consumer Action Panel
20 North Wacker Drive
Chicago, IL 60606

- MACAP will in turn inform us of your action.

***When calling or writing for help or service:**
Please provide a detailed description of the problem, your appliance's complete model and serial numbers and the purchase date. (See page 2.) This information will help us respond properly to your request.

POWER CLEAN™ washing system parts covered by your warranty

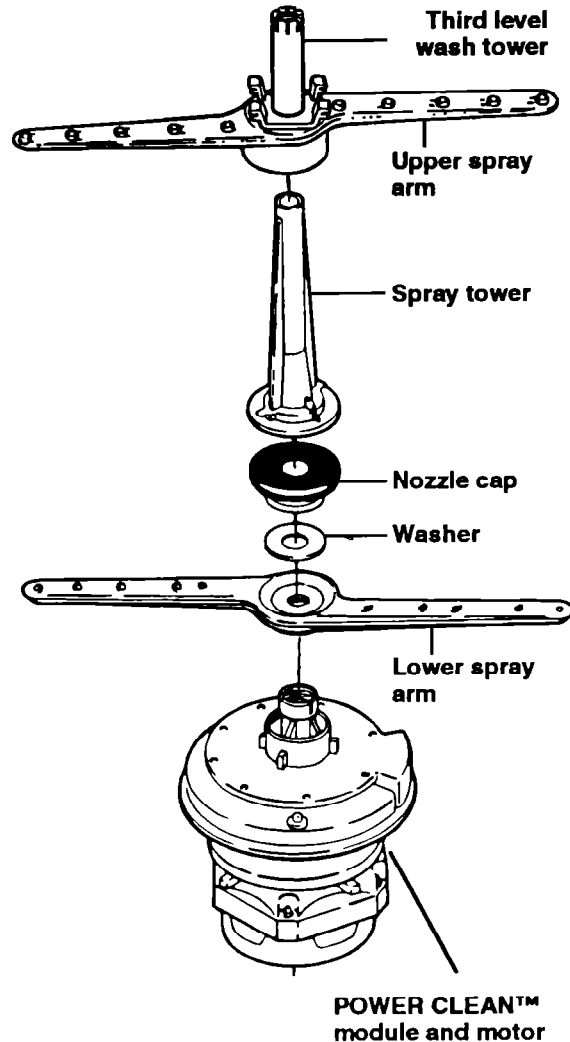

WHIRLPOOL® Dishwasher Warranty

LENGTH OF WARRANTY	WHIRLPOOL WILL PAY FOR
FULL ONE-YEAR WARRANTY From Date of Purchase	FSP® replacement parts and repair labor to correct defects in materials or workmanship. Service must be provided by an authorized Whirlpool® service company.
LIMITED ONE-YEAR WARRANTY Second Year From Date of Purchase	FSP replacement parts for any part of the POWER CLEAN™ Washing System if defective in materials or workmanship. These parts are shown on page 27 of this book.
FULL TWENTY-YEAR WARRANTY From Date of Purchase	FSP replacement parts and repair labor for the DURAPERM™ tub and/or inner door should they fail to contain water due to defective materials or workmanship. Service must be provided by an authorized Whirlpool service company.
WHIRLPOOL WILL NOT PAY FOR	
<p>A. Service calls to:</p> <ol style="list-style-type: none"> 1. Correct the installation of the dishwasher. 2. Instruct you how to use the dishwasher. 3. Replace house fuses or correct house wiring or plumbing. <p>B. Repairs when dishwasher is used in other than normal, single-family household use.</p> <p>C. Pickup and delivery. This product is designed to be repaired in the home.</p> <p>D. Damage to dishwasher caused by accident, misuse, fire, flood, acts of God or use of products not approved by Whirlpool.</p> <p>E. Any labor costs during limited warranty.</p> <p>F. Repairs to parts or systems caused by unauthorized modifications made to the appliance.</p>	

7/93

WHIRLPOOL CORPORATION SHALL NOT BE LIABLE FOR INCIDENTAL OR CONSEQUENTIAL DAMAGES. Some states do not allow the exclusion or limitation of incidental or consequential damages, so this limitation or exclusion may not apply to you. This warranty gives you specific legal rights, and you may also have other rights which vary from state to state.

Outside the United States, a different warranty may apply. For details, please contact your authorized Whirlpool distributor or military exchange.

If you need service, first see the "Assistance or Service" section of this book. After checking "Assistance or Service," additional help can be found by calling our Consumer Assistance Center telephone number, 1-800-253-1301, from anywhere in the U.S.A.



Printed on recycled paper—
10% post consumer waste
50% recovered materials

PART NO. 3373739 Rev. A

© 1993 Whirlpool Corporation

® Registered Trademark / TM Trademark of Whirlpool Corporation.

Printed in U.S.A.